



# Sienna Collection

Colours represented are to be used as a guide only.  
Please refer to manufacturers swatch for a more accurate colour match.

Please note that colour shadings can vary slightly from each roll of fabric.  
We cannot guarantee a precise match to these samples or between cut lengths and upholstered goods.

foamflex™

Award Winning Seating Technology

24/06/2020



# SIENNA COVER GUIDE - PILLOW BACK & STANDARD BACK

Please use this guide when ordering the following pieces to clarify cover options.

## STANDARD BACK

Corner Group: LH2, RFC, FST (L2, RFC, P)

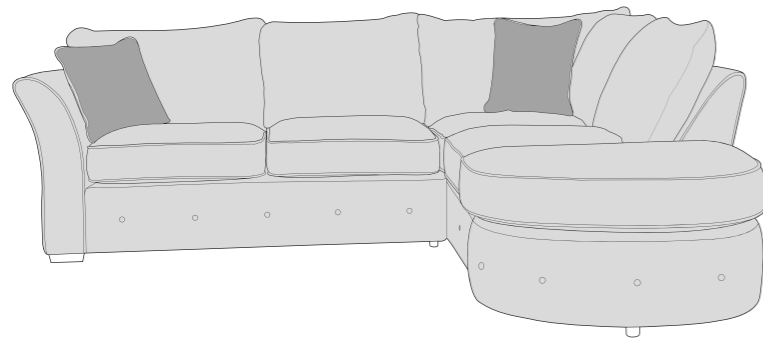

3 Seater Sofa (3ST)

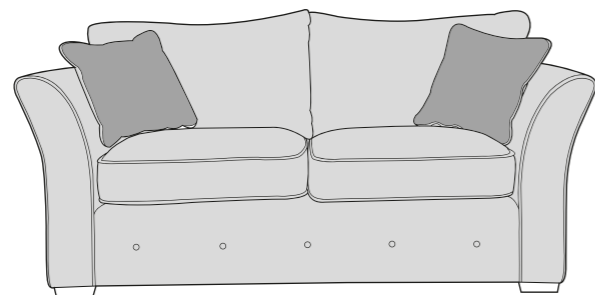

Corner Group: FST, LFC, RH2 (P, LFC, R2)

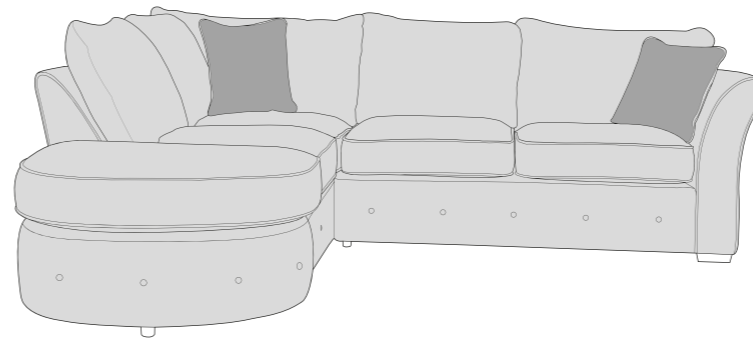

2 Seater Sofa (2ST)

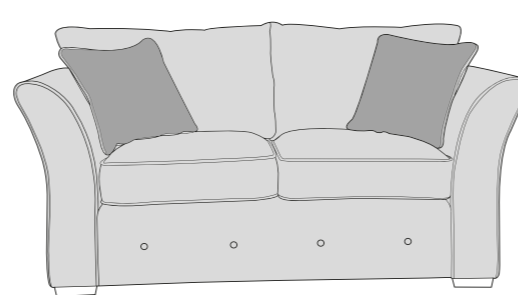

Arm Chair (1ST)

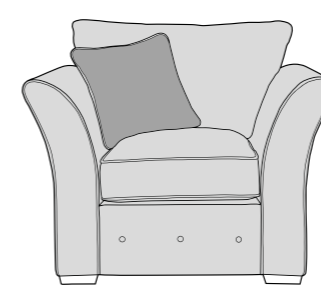

## PILLOW BACK

Corner Group: LH2, RFC, FST (L2, RFC, P)

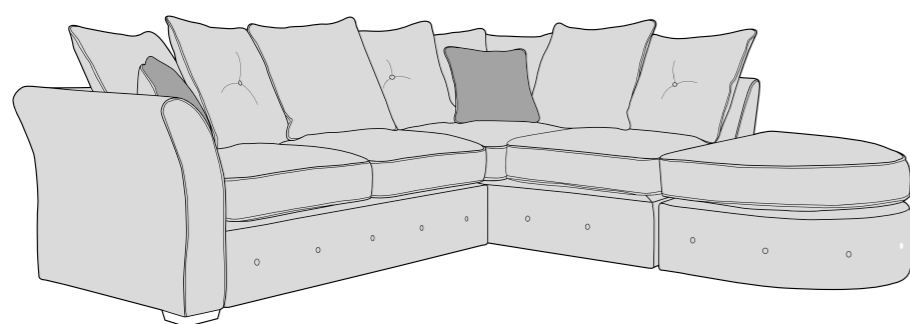

3 Seater Sofa (3ST)

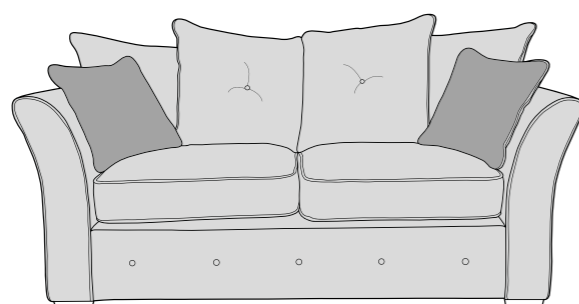

Corner Group: FST, LFC, RH2 (P, LFC, R2)

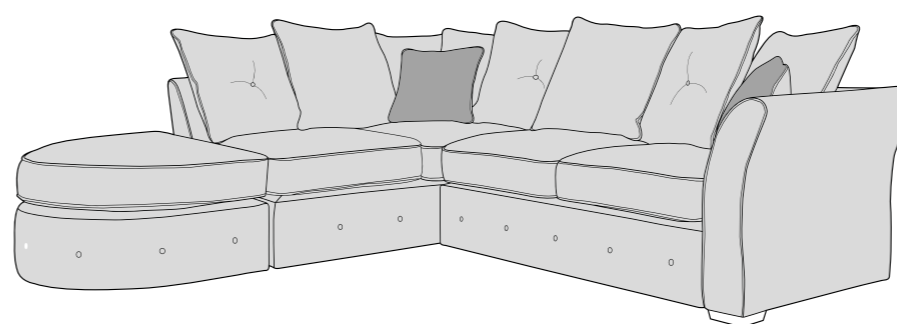

2 Seater Sofa (2ST)

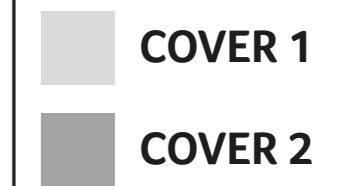
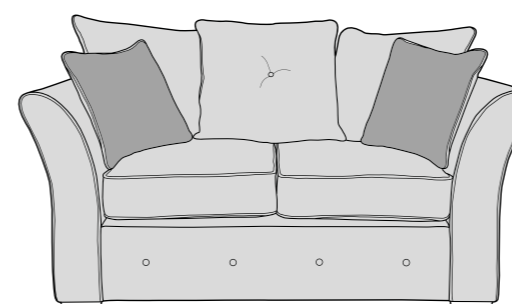

Standard Back & Pillow Back Scatter Cushions

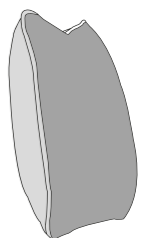

Front = Cover 2  
Piping = Cover 1  
Back = Cover 1

FOOT OPTIONS:

Natural (light)    Brown (dark)



Wood is a natural product and will vary in shade/colour from item to item. Feet may require fitting.



# SIENNA DIMENSIONS (CM)

AVAILABLE PIECES	HEIGHT 1	WIDTH 2	DEPTH 3	SEAT HEIGHT 4	SEAT DEPTH (STD) 5	SEAT DEPTH (PILLOW) 5	SEAT WIDTH 6	ACCESS DIAGONAL 7	WEIGHT (KG)	PILLOW BACK NO.	SCATTER CUSHION NO.
LH2, RFC, FST GROUP or RH2, LFC, FST GROUP	88	275	237	50	53	53	N/A	N/A	100.2	8 (4 Plain, 4 Buttoned)	2
LH2/RH2 UNIT	88	165	92	50	53	53	142	186	39.5	3 (2 Plain, 1 Buttoned)	1
LFC/RFC UNIT	88	163	92	50	53	53	127	186	42.2	5 (2 Plain, 3 Buttoned)	1
LARGE FOOTSTOOL (FST)	50	92	74	N/A	N/A	N/A	N/A	N/A	18.5	N/A	N/A
3 SEATER SOFA (3ST)	88	186	92	50	53	53	141	203	48	4 (2 Plain, 2 Buttoned)	2
2 SEATER SOFA (2ST)	88	160	92	50	53	53	116	182	44	3 (2 Plain, 1 Buttoned)	2
ARM CHAIR (1ST)	88	105	92	50	53	53	60	134	31.5	N/A	1



- \* Hardwood & composite board frame.
- \* Dowelled, screwed, glued & stapled joinery.
- \* Light & Dark Wood foot options.
- \* Reversible pillow back cushions for durability and comfort.

- \* Available with Pillow or Standard back cushions.
- \* Award winning foamflex seat interior.
- \* 5 Year guarantee on seat interior.
- \* Fibre Filled backs for added comfort.

## DIMENSION GUIDE

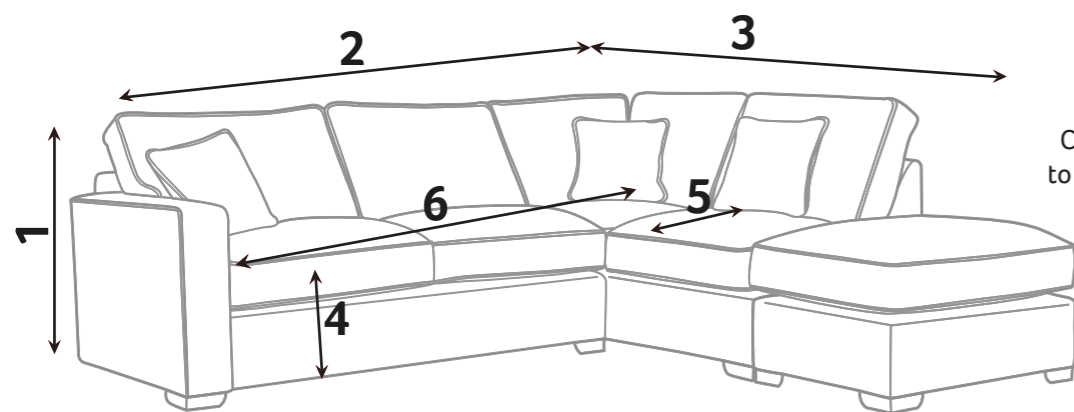

- 1 - HEIGHT
- 2 - WIDTH
- 3 - DEPTH
- 4 - SEAT HEIGHT
- 5 - SEAT DEPTH (STD & PILLOW)
- 6 - SEAT WIDTH

Check the diagonal access dimension to ensure furniture will fit in your home.

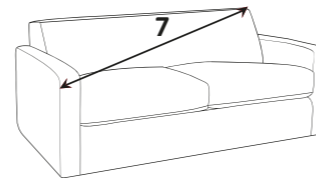

Illustrations used for reference only.

## foamflex™

Our new, expertly engineered foam seat interior gives you the comfort of fibre with the retention of foam. Our foamflex seat interiors have been granted the FIRA GOLD Award, a mark of quality under-pinning all necessary testing of the product materials, design and production techniques.

## CARE GUIDE

To improve the longevity of your hand-made furniture, we recommend rotating cushions (where applicable).

For further information on maintaining your furniture, please refer to the Care Guide located under the seat platform.



Our foamflex seat interiors have been granted the FIRA GOLD Award, a mark of quality under-pinning all necessary testing of the product materials, design and production techniques.

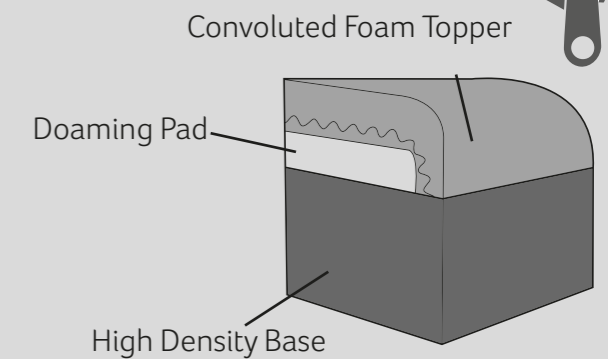

Mid Oak (Light)      Antique (dark)

## FOOT OPTIONS:



Wood is a natural product and will vary in shade/colour from item to item. Feet may require fitting.

Please note : All dimensions are approximate. Allow tolerance of +/- 2.5cm.

